

Battery type	12V 65Ah +R LB2	Product code	GB0650B
--------------	-----------------	--------------	---------

Specification	
Nominal voltage	12 V
Capacity (C20)	65 Ah at 25°C to 10,5V
Reserve capacity (25A discharge)	88 min
Cold cranking current (EN 18°C)	560 A
Cold cranking current (DIN 18°C)	335 A
Weight	14.8 kg ± 5%
Technology	Flooded/SLI

Overall dimensions	
Length	242 +0/-2 mm
Width	175 +0/-2 mm
Height	175 +0/-3 mm
Base hold-down	B13
Layout	0
Terminal type	1
Container material	PP
Box color	Black
Lid color	Black

Electrolyte	
Electrolyte type	H ₂ SO ₄
Electrolyte spec density at 25°C	1.28 ± 0.01 g/cm ³

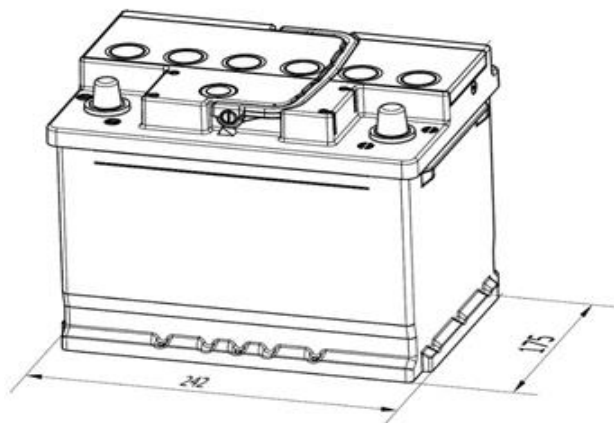

Cell properties	
Grid prod. technology	Punched
+ grid alloy	PbCa
+ strip / grid thickness	0.9 / 1.3 mm
(-) grid	CE-
Grid prod. technology	Expanded
- grid alloy	PbCa
- strip / grid thickness	0.75 / 1.25 mm
Separator	
Type	PE
Thickness	1.0 - 1.2 mm

Drawings	
Base hold-down	Layout

Terminal type	Key characteristics
	<ul style="list-style-type: none"> - Maintenance free - Wide range of application - Universal EN design - Lid type: K2 with push in plug